

Series 1300A

product guide

features

- All New Design
- 110 ft (33.52 m)
Four-Section Boom
- 30 USt (27.2 t) Rating
- Self-lubricating "Easy
Glide" Wear Pads
- Internal
Anti-two-block
- NEW VISION
CAB™



contents

Features	2
Mounting Configurations	3
Specifications	4
Capacities	5
Accessories	10
Dimensions Specifications	11

features

Why Buy a National Crane Series 1300A?

2



*Product may be shown with optional equipment.

- **30 USt Rating (27.2 t)** – The new 1300A is a 30 USt machine and has increased capacities over the former Series 1300 model.
- **110 ft (33.52 m) Four-section Boom** – The longest in its size range. The longer boom allows the operator to perform more lifts without the use of a jib, reducing setup time and improving efficiency. A 69 ft (21 m) four-section boom or a 100 ft (30.5 m) four-section boom is also available.
- **Overload Protection** – All National Crane boom trucks are equipped with overload protection:
 - Load Moment Indicator (LMI) is standard on all series 1300A machines.
 - LMI with WADS (Working Area Definition System) display console is weatherproof.
 - LCD display is visible in full or low light.
 - All crane load lifting values are displayed simultaneously.
- **Self-lubricating “Easy Glide” Boom Wear Pads** – The self-lubricating boom pads, standard on the 1300A, reduce the conditions that cause boom chatter and vibration. The net result is smoother crane operation.
- **“HO”-style Outriggers** – Two sets of “HO”-style outriggers with 20 ft (6.09 m) span, with 14 ft (4.27 m) mid span setting with manual locks and reduced capacity chart and fully retracted outrigger spread with reduced capacity chart. Outriggers are equipped with removable ball and socket aluminum foot pads. Independent outrigger controls (umbilical design) are located at rear of the crane and includes level indicator (sight bubble).
- **Continuous Rotation/Glide Swing** – The series 1300A is supplied with 360° continuous rotation as standard, along with the “glide swing” feature - allowing free swing during rotation - and a manually applied foot brake.
- **Adjustable Swing Speed** – Standard on the 1300A. A control knob located on the swing motor brake release valve can be easily adjusted to the crane operator’s swing speed preference.
- **Oil Cooler** – Radiator mounted on top of front outriggers with electric fan is standard.
- **Heavier-duty Torsion Box** – The stronger standard torsion box improves rigidity, reduces truck frame flex and reduces the need for turret mounted counterweight.
- **Speedy-reeve Boom Tip and Sheave Blocks** – These standard features simplify rigging changes by decreasing the time needed to change line reeving.
- **Electronic versions of manuals available through Manitowoc Crane CARE.**
- **Pre-painted Components** – Painting crane components before assembly reduces the possibility of rust, improves serviceability and enhances the appearance of the machine.
- **Deluxe Operator’s Cab** – NEW VISION CAB™ has a rigid powder coated steel structure, is well insulated, with ample safety glass for operator visibility and comfort. Multi-position seat with arm rest and single axis joystick controls, ventilation fans, diesel heater, wipers. Optional air conditioning is available. Optional open-seat control station in lieu of enclosed cab is available.
- **Improved Serviceability** –
 - Bearings on the boom extend and retract cables can be greased through access holes in the boom side plates.
 - Number of internal boom parts has been reduced, decreasing service time when rebuilding the machine.
- **New State-of-the-art Control Valve** – Provides smoother operation. The new design eliminates parts, reducing repair costs and improving the machine’s serviceability.
- **National Crane is the Market Leader** – National Crane is number one in the production of commercial truck-mounted boom trucks, with more than 35,000 units sold. National Crane has many programs and people directly and indirectly involved to provide our customers with reliable products.
 - National Crane has the boom truck industry’s leading test program. Every structural part of the crane is cycle tested up to 60,000 cycles at full capacity. In addition to cycle testing, each model is subjected to state-of-the-art strain gauge testing that measures metal deformation as small as one one-millionth of an inch. The net result is that any weak areas are caught in test, not on job sites where costly downtime occurs.
 - Lift and telescoping cylinders are manufactured by National Crane, so that the seals, packing glands, and end plates are traced for accurate shipment of replacement parts.
 - Parts are available for all National Crane machines for the life of the crane.
 - National Crane has a formalized quality program and is ISO 9001 approved.
- **National Crane’s Quality Management System is ISO 9001:2000 Approved.**

- 30 USt (27.2 t) maximum capacity
- 163 ft (49.68 m) w/optional jib maximum vertical reach*
- 119 ft (36.27 m) maximum vertical hydraulic reach*
- Load Moment Indicator system (LMI) with WADS
- Proportional boom extension
- High performance planetary winch
- Heavy-duty triple pump hydraulics
- * Maximum vertical reach is ground-level to boom tip height at maximum extension and angle with outriggers/stabilizers fully extended.

1300A

mounting configuration

1300A TRUCK REQUIREMENTS

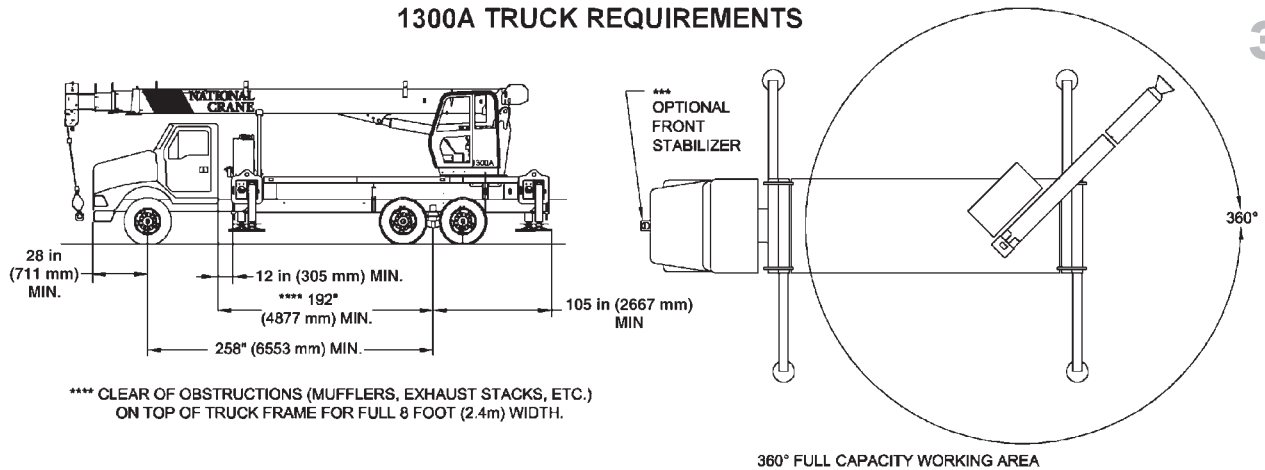

The mounting configuration shown is based on an 85% stability factor. The complete unit must be installed on the truck in accordance with factory requirements, and a test performed to determine actual stability and counterweight requirements, since individual truck chassis vary. If bare truck weights are not met, counterweight will be required. A summary of mounting and truck requirements are:

Working area
360°

Gross Axle Weight Rating (GAWR),
front 18,000 lb (8 165 kg)

Gross Axle Weight Rating (GAWR),
rear 34,000 lb (15 455 kg)

Gross Vehicle Weight Rating
52,000 lb (23 587 kg)

Wheelbase (WB)
258 in (6.55 m)

Cab to Axle/Trunnion (CT)
192 in (4877mm);

After Frame (AF)
105 in (2667mm) minimum

Frame Section Modulus (SM), front axle to end of
afterframe: 110,000 psi (759 MPa) 20 in3 (327-cm3)
See "Truck Frame Strength" section.

Estimated bare chassis weight required for stability
prior to installation of crane or accessories:
Front 9,000 lb (4082 kg)
Rear 8,500 lb (3856 kg)*
10,000 lb (4536 kg) with optional bed

Front Axle Maximum Weight**
10,500 lb (4763 kg)

*10,000 lb (4536 kg) is required at the rear axle for
360° stability. This weight does include the weight of
the optional bed. Counterweight will be required above

the 8500 lb (3856 kg) minimum bare chassis if the
optional bed is not used to attain the 10,000 lb (4536
kg) stability weight.

**Weight in excess of 10,500 lb (4763 kg) will require
the addition of a front stabilizer or additional rear axle
stability weight for over front stability. One-half of the
front axle weight in excess of the maximum at the rear
axle will maintain stability.

Example: A 11,000 lb (4990 kg) Bare Front Axle will
maintain stability if the rear axle bare is 8750 lb (3969
kg) and 10,250 lb (4649 kg) with the additional optional
bed weight.

***A single front stabilizer is not necessary for 360°
stability if mounting dimensions are maintained and
minimum rear axle and maximum front axle weights
are not exceeded.

NOTE 1: Gross Vehicle Weight Rating (GVWR) is
dependent on all components of the vehicle
(axles, tires, springs, frame, etc.) meeting
manufacturers' recommendations; always
specify GVWR when purchasing trucks.

NOTE 2: Diesel engines require a variable speed
governor and energize-to-run fuel solenoid
for smooth crane operation; electronic fuel
injection is required.

NOTE 3: All mounting data is based on a National
Series 1300A with subbase and an 85%
stability factor.

NOTE 4: The complete unit must be installed in
accordance with factory requirements, and
a test performed to determine actual
stability and counterweight requirements;
contact the factory for details.

NOTE 5: Transmission neutral safety interlock switch
is required.

3

1300A

specifications

Boom and Jib Combinations Data

Available in three basic models.

4

Model 1369A — Equipped with a 22-69 ft (6.7-21.03 m) four-section boom. Maximum tip height is 78 ft (23.77 m).

22-69 ft (6.7-21.03 m) four-section boom.



Model 13100A — Equipped with a 29-100 ft (8.83-30.48 m) four-section boom. This model can be equipped with a 25-44 ft (7.62-13.41 m) two section jib. Maximum tip height w/44ft (13.41 m) jib is 153 ft (44.63 m).

29-100 ft (8.83-30.48 m) four-section boom.

13FJ44M 25-44 ft (7.62-13.41 m) two-section jib



Model 13110A — Equipped with a 33-110 ft (10.05-33.52 m) four-section boom. This model can be equipped with a 25-44 ft (7.62-13.41 m) two-section jib. Maximum tip height w/44ft (13.41 m) jib is 163 ft (49.68 m).

32-110 ft (10.05-33.52 m) four-section boom.







13FJ44M 25-44 ft (7.62-13.41 m) two-section jib



Note: Maximum tip height is measured with outriggers/stabilizers fully extended.

1300A Winch Data

- Do not deadhead line block against boom tip when extending boom.
- Keep at least 3 wraps of loadline on drum at all times.
- Use only 9/16 in diameter rotation-resistant cable with 38,500 lb breaking strength on this machine.

			1 Part Line	2 Part Line	3 Part Line	4 Part Line	5 Part Line	6 Part Line	7 Part Line
									
MAXIMUM BOOM LENGTH AT MAXIMUM ELEVATION WITH RIGGING SHOWN WITH LOAD BLOCK AT GROUND LEVEL			100 ft boom / jib	100 ft	75 ft	60 ft	50 ft	43 ft	36 ft
			110 ft boom / jib	110 ft	94 ft	78 ft	62 ft	46 ft	32 ft
Winch	Average Cable Supplied	Breaking Strength	Lift and Speed	Lift and Speed	Lift and Speed	Lift and Speed	Lift and Speed	Lift and Speed	Lift and Speed
Standard Planetary Winch	9/16 in Diameter Rotation Resistant	38,500 lb (17,464 kg)	7,700 lb (3,493 kg) 164 fpm (50 m/min)	15,400 lb (6,986 kg) 82 fpm (25 m/min)	23,100 lb (10,478 kg) 55 fpm (16 m/min)	30,800 lb (13,971 kg) 41 fpm (12 m/min)	38,500 lb (17,464 kg) 33 fpm (10 m/min)	46,200 lb (20,956 kg) 27 fpm (8 m/min)	53,900 lb (24,449 kg) 23 fpm (7 m/min)
"Burst of Speed"	9/16 in Diameter Rotation Resistant	38,500 lb (17,464 kg)	3,000 lb (1,361 kg) 265 fpm (111 m/min)	6,000 lb (2,722 kg) 132 fpm (40 m/min)	9,000 lb (4,083 kg) 88 fpm (27 m/min)	12,000 lb (5,443 kg) 66 fpm (20 m/min)	15,000 lb (6,804 kg) 53 fpm (16 m/min)	18,000 lb (8,165 kg) 44 fpm (13 m/min)	21,000 lb (9,526 kg) 38 fpm (11 m/min)

All winch pulls and speeds in this chart are shown on the fourth layer. Winch line pulls would increase on the first, second and third layers. Winch line speed would decrease on the first, second and third layers. Winch line pulls may be limited by the winch capacity or the ANSI 5 to 1 cable safety factor. These are shown below:

Winch	4th Layer Drum Pull	Allowable Cable Pull
Standard planetary	7,700 lb (3,493 kg) (low speed) 3,000 lb (1,361 kg) ("burst of speed")	7,700 lb (3,492 kg)

Block Type	Rating	Weight
Downhaul Weight	5 USt (4.53t)	150 lb (68 kg)
1 Sheave Block	12 USt (10.89t)	305 lb (139 kg)
2 Sheave Block	19 USt (17.24t)	350 lb (159 kg)
3 Sheave Block	30 USt (27.22t)	575 lb (261 kg)

1300A

capacities

5

Load Chart Rating: Series 1369A (21 m) Boom / Full-Span Outrigger 20 ft (6.0 m)

National Crane will send you a chart on request – or you may secure needed load rating information through your nearest National Crane dealer.

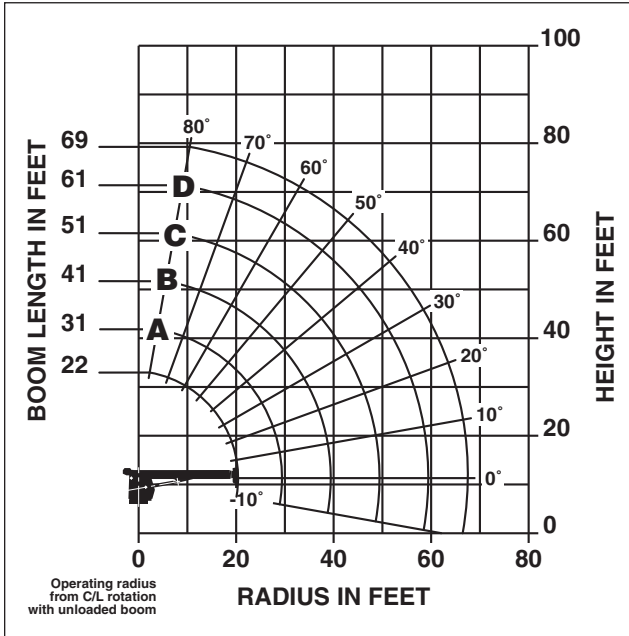

CAUTION:

- Do not operate crane booms, jib extensions, any accessories or loads within 10 ft (3m) of live power lines or other conductors of electricity.
- Jib and boom capacities shown are maximum for each section.
- Do not exceed capacities at reduced radii.
- Load ratings shown on the appropriate charts are maximum allowable loads with the crane mounted on a factory-approved truck and all outriggers at either full span or at mid span range and set on a firm level surface so that the crane is level and all tires are suspended.
- Always level the crane with the level indicator located on the crane.
- The operator must reduce load to allow for factors such as wind, ground conditions, operating speeds and their effects on freely suspended loads.
- Overloading this crane may cause structural collapse or instability.
- Weights on any accessories attached to the boom or loadline must be deducted from the load chart capacities.
- Do not exceed jib capabilities at any reduced boom lengths.
- Do not deadhead lineblock against boom tip when extending boom or winching up.
- Keep at least three wraps of loadline on drum at all times.
- Use only specified cable with this machine.

**SERIES 1369A
NO JIB /
FULL-SPAN
OUTRIGGER 20 ft**

LOADLINE EQUIPMENT DEDUCT
Downhaul weight.....150 lb (68 kg)
One sheave block266 lb (120 kg)
Two sheave block.....350 lb (159 kg)
Three sheave block.....575 lb (261 kg)

Load Chart Rating: Series 1369A (21 m) Boom / Full-Span Outrigger 20 ft (6.0 m)

22 ft – 69 ft (6.7 – 21.03 M) BOOM RATED LOADS WITHOUT JIB

LOADED RADIUS (ft)	LOADED BOOM ANGLE (deg)	22 ft BOOM (lb)	LOADED BOOM ANGLE (deg)	A 31 ft BOOM (lb)	LOADED BOOM ANGLE (deg)	B 41 ft BOOM (lb)	LOADED BOOM ANGLE (deg)	C 51 ft BOOM (lb)	LOADED BOOM ANGLE (deg)	D 61 ft BOOM (lb)	LOADED BOOM ANGLE (deg)	69 ft BOOM (lb)
5	74.5	* 60,000										
8	66	47,500	74	33,500	78.5	33,400						
10	59.5	40,300	70	33,100	75.5	32,300	79.5	35,000				
12	52.5	34,900	66	32,700	72.5	31,100	77	30,100	80	29,000		
15	41.5	28,600	59.5	27,300	68	25,900	73.5	24,900	77	24,200	79	19,350
20			47	21,200	60	20,300	67	19,500	72	18,850	74.5	18,450
25			32	16,550	51	16,600	60.5	16,000	66.5	15,450	70	15,050
30					41	13,800	53.5	13,500	61	13,050	65.5	12,700
35					27.5	10,900	46	11,050	55.5	11,150	60.5	10,950
40							37	8,750	49	8,850	55.5	8,950
45							26	7,200	42.5	7,300	50	7,350
50									34.5	6,050	44	6,100
55									24	5,100	37	5,150
60											29	4,350
65											17.5	3,700
	0	13,300	0	8,500	0	5,700	0	4,050	0	2,950	0	2,300

*SHADED AREAS ARE STRUCTURALLY LIMITED CAPACITIES

THIS CHART IS ONLY A GUIDE AND SHOULD NOT BE USED TO OPERATE THE CRANE. The individual crane's load chart, operating instructions and other instructional plates must be read and understood prior to operating the crane.

1300A

capacities

Load Chart Rating: Series 13100A (30.5 m) Boom with 25-44 ft (7.62 m – 13.4 m) Jib / Full-Span Outrigger 20 ft (6.0 m)

National Crane will send you a chart on request – or you may secure needed load rating information through your nearest National Crane dealer.

6

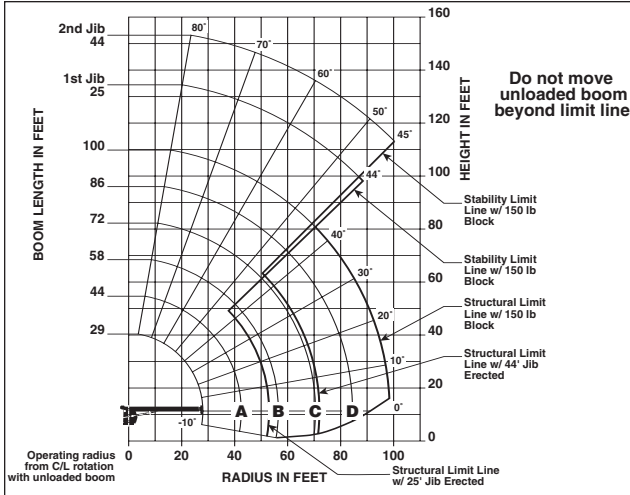

CAUTION:

- Do not operate crane booms, jib extensions, any accessories or loads within 10 ft (3m) of live power lines or other conductors of electricity.
- Jib and boom capacities shown are maximum for each section.
- Do not exceed capacities at reduced radii.
- Load ratings shown on the appropriate charts are maximum allowable loads with the crane mounted on a factory-approved truck and all outriggers at either full span or at mid span range and set on a firm level surface so that the crane is level and all tires are suspended.
- Always level the crane with the level indicator located on the crane.
- The operator must reduce load to allow for factors such as wind, ground conditions, operating speeds and their effects on freely suspended loads.
- Overloading this crane may cause structural collapse or instability.
- Weights on any accessories attached to the boom or loadline must be deducted from the load chart capacities.
- Do not exceed jib capabilities at any reduced boom lengths.
- Do not deadhead lineblock against boom tip when extending boom or winching up.
- Keep at least three wraps of loadline on drum at all times.
- Use only specified cable with this machine.

**SERIES 13100A
WITH
25-44 ft JIB/
FULL-SPAN
OUTRIGGER 20 ft**

NOTE:

1. Operate with jib by radius when main boom is fully extended. If necessary increase boom angle to maintain loaded radius.
2. Operate with jib by boom angle when main boom is not fully extended. Do not exceed rated jib capacities at any reduced boom lengths.

LOADLINE EQUIPMENT DEDUCT
Downhaul weight.....150 lb (68 kg)
One sheave block266 lb (120 kg)
Two sheave block.....350 lb (159 kg)
Three sheave block.....575 lb (261 kg)

Load Chart Rating: Series 13100A (30.5 m) Boom with 25-44 ft (7.62 m – 13.4 m) Jib / Full-Span Outrigger 20 ft (6.0 m)

29 TO 100 ft (8.83 – 30.48 m) BOOM RATED LOADS WITHOUT JIB

LOADED RADIUS (ft)	LOADED BOOM ANGLE (deg)	29 ft BOOM (lb)	LOADED BOOM ANGLE (deg)	A 44 ft BOOM (lb)	LOADED BOOM ANGLE (deg)	B 58 ft BOOM (lb)	LOADED BOOM ANGLE (deg)	C 72 ft BOOM (lb)	LOADED BOOM ANGLE (deg)	D 86 ft BOOM (lb)	LOADED BOOM ANGLE (deg)	100 ft BOOM (lb)
5	79.5	* 60,000										
8	73	44,000	79	29,100								
10	68.5	36,900	76.5	29,000								
12	65	31,900	74	28,600	78.5	28,600						
15	57	26,400	69.5	24,600	75.5	23,500	79.5	22,900				
20	46	20,100	62.5	19,000	70.5	18,050	75.5	17,450	78.5	16,300	80	10,650
25	29	14,800	55	15,350	65	14,600	71	14,050	75.5	13,700	77.5	10,450
30			46.5	12,300	59	12,150	66.5	11,700	71.5	11,350	75	10,000
35			36	9,700	53	10,000	62	9,900	68	9,600	72	9,400
40			22	7,700	46	8,050	57.5	8,300	64	8,250	69	8,050
45					38.5	6,500	52.5	6,700	60	6,900	66	7,000
50					29	5,200	47	5,450	56	5,600	62	5,750
55					15	4,200	40.5	4,400	52	4,600	59	4,700
60							33.5	3,600	47.5	3,800	55.5	3,900
65							24.5	2,950	42	3,100	51.5	3,250
70							10	2,100	36.5	2,550	47.5	2,700
75									29.5	2,100	43	2,200
80									21	1,650	38.5	1,800
85											33	1,450
90											26.5	1,100
95											17.5	750
100												
0		7,900	0	4,100	0	2,250	0	1,100				

25 TO 44 ft JIB RATED LOADS			
LOADED RADIUS (ft)	LOADED BOOM ANGLE (deg)	25 ft JIB (lb)	44 ft JIB (lb)
30	78	5,100	
35	76	5,100	78
40	75	4,950	76
45	71	4,450	74
50	69	4,150	72
55	67	3,850	70.5
60	64	3,550	68.5
65	62	3,200	66.5
70	59	2,500	64.5
75	56	2,100	62
80	52.5	1,650	59.5
85	49.5	1,250	57.5
90	45	900	55
95	42	550	52.5
100			48.5
105			45.5
110			600

*SHADED AREAS ARE STRUCTURALLY LIMITED CAPACITIES

1300A

BOOM LENGTH (ft)	25 – 44 ft JIB STOWED
29	Reduce load 800 lb
44	Reduce load 600 lb
58	Reduce load 450 lb
72	Reduce load 350 lb
86	Reduce load 300 lb
100	Reduce load 250 lb

RATED LOAD REDUCTIONS WITH STOWED JIB

Note:

1. All capacities are in pounds, angles in degrees, and radii in feet.
2. Loaded boom angles are given as reference only.
3. Shaded areas are structurally limited capacities.
4. Handling of personnel is only permitted with full span extension of all outrigger and stabilizer beams.
- *5. See owners manuals. The 60,000 lb load requires optional 9/16" diameter 6x25 IWRC cable.

THIS CHART IS ONLY A GUIDE AND SHOULD NOT BE USED TO OPERATE THE CRANE. The individual crane's load chart, operating instructions and other instructional plates must be read and understood prior to operating the crane.

capacities

7

Load Chart Rating: Series 13100A (30.5 m) Boom with 25-44 ft (7.62 m-13.4 m) Jib / Mid-Span Outrigger 14 ft (4.3 m)

National Crane will send you a chart on request – or you may secure needed load rating information through your nearest National Crane dealer.

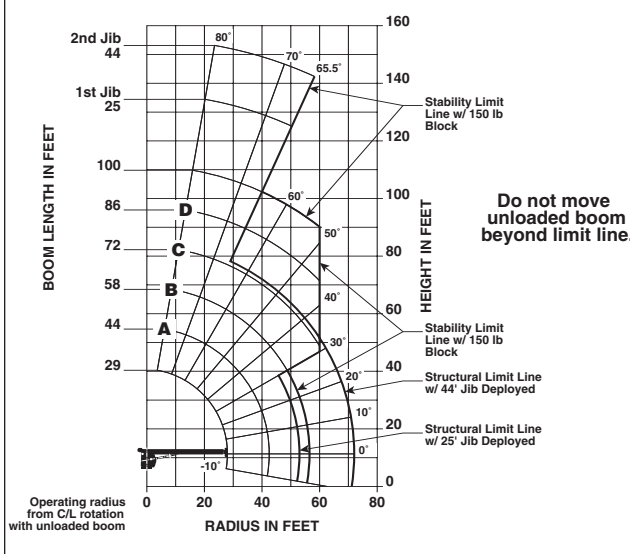

CAUTION:

- Do not operate crane booms, jib extensions, any accessories or loads within 10 ft (3m) of live power lines or other conductors of electricity.
- Jib and boom capacities shown are maximum for each section.
- Do not exceed capacities at reduced radii.
- Load ratings shown on the load rating charts are maximum allowable loads with the outriggers properly extended and the outrigger lock pins engaged on a firm, level surface and the crane leveled and mounted on a factory recommended truck.
- Always level the crane with the level indicator located on the crane.
- The operator must reduce load to allow for factors such as wind, ground conditions, operating speeds and their effects on freely suspended loads.
- Overloading this crane may cause structural collapse or instability.
- Weights on any accessories attached to the boom or loadline must be deducted from the load chart capacities.
- Do not exceed jib capabilities at any reduced boom lengths.
- Do not deadhead lineblock against boom tip when extending boom or winching up.
- Keep at least three wraps of loadline on drum at all times.
- Use only specified cable with this machine.

**SERIES 13100A
WITH
25-44 ft JIB /
MID-SPAN
OUTRIGGER 14 ft**

LOADLINE EQUIPMENT DEDUCT

Downhaul weight.....150 lb (68 kg)
One sheave block.....266 lb (120 kg)
Two sheave block.....350 lb (159 kg)
Three sheave block.....575 lb (261 kg)

NOTE:

- Operate with jib by radius when main boom is fully extended. If necessary increase boom angle to maintain loaded radius.
- Operate with jib by boom angle when main boom is not fully extended. Do not exceed rated jib capacities at any reduced boom lengths.

Load Chart Rating: Series 13100A (30.5 m) Boom with 25-44 ft (7.62 m-13.4 m) Jib / Mid-Span Outrigger 14 ft (4.3 m)

29 TO 100 ft (8.83 – 30.48 m) BOOM RATED LOADS WITHOUT JIB

LOADED RADIUS (ft)	LOADED BOOM ANGLE (deg)	29 ft BOOM (lb)	LOADED BOOM ANGLE (deg)	A 44 ft BOOM (lb)	LOADED BOOM ANGLE (deg)	B 58 ft BOOM (lb)	LOADED BOOM ANGLE (deg)	C 72 ft BOOM (lb)	LOADED BOOM ANGLE (deg)	D 86 ft BOOM (lb)	LOADED BOOM ANGLE (deg)	100 ft BOOM (lb)
5	79	* 60,000										
8	72.5	41,600	79	29,100								
10	68.5	35,100	76.5	29,000								
12	65	30,500	73.5	28,600	78.5	27,000						
15	57.5	23,950	69.5	24,600	75.5	22,100	79	21,500				
20	45	13,000	62	13,900	70	14,450	75	14,950	78	14,950	80	10,650
25	28	8,100	55	8,900	64	9,400	70	9,750	74	10,200	77.5	10,200
30			46.5	6,050	58.5	6,500	66	6,750	70.5	7,050	74.5	7,200
35			36	4,150	53	4,600	61	4,950	67	5,150	71	5,300
40			22.0	2,850	45.5	3,300	56.5	3,600	63	3,850	67.5	4,000
45					38	2,350	51	2,600	59	2,900	64	3,000
50					29	1,600	46	1,850	55	2,050	61	2,200
55					14.5	1,000	41	1,250	51	1,450	57	1,600
60							33	800	46.5	900	54.5	1,000
65											51	650
70												
0		5,400	0	2,350	0	900						

*SHADED AREAS ARE STRUCTURALLY LIMITED CAPACITIES

25 TO 44 ft JIB RATED LOADS			
LOADED RADIUS (ft)	LOADED BOOM ANGLE (deg)	25 ft JIB (lb)	LOADED BOOM ANGLE (deg)
30	77.5	5,100	
35	75.5	5,100	79.5
40	73.5	3,750	78
45	70.5	2,700	75.5
50	66	1,250	74
55	63	700	70
60			67.5
65			65
70			62.5

BOOM LENGTH (ft)	25 - 44 ft JIB STOWED
29	Reduce load 800 lb
44	Reduce load 600 lb
58	Reduce load 450 lb
72	Reduce load 350 lb
86	Reduce load 300 lb
100	Reduce load 250 lb

RATED LOAD REDUCTIONS WITH STOWED JIB

Note:

- All capacities are in pounds, angles in degrees, and radii in feet.
- Loaded boom angles are given as reference only.
- Shaded areas are structurally limited capacities.
- Handling of personnel is only permitted with full span extension of all outrigger and stabilizer beams.
- See owners manuals. The 60,000 lb load requires optional 9/16" diameter 6x25 IWRC cable.

THIS CHART IS ONLY A GUIDE AND SHOULD NOT BE USED TO OPERATE THE CRANE. The individual crane's load chart, operating instructions and other instructional plates must be read and understood prior to operating the crane.

capacities

Load Chart Rating: Series 13110A (33.5 m) Boom with 25-44 ft (7.62 m-13.4 m) Jib / Full-Span Outrigger 20 ft (6.0 m)

National Crane will send you a chart on request – or you may secure needed load rating information through your nearest National Crane dealer.

8

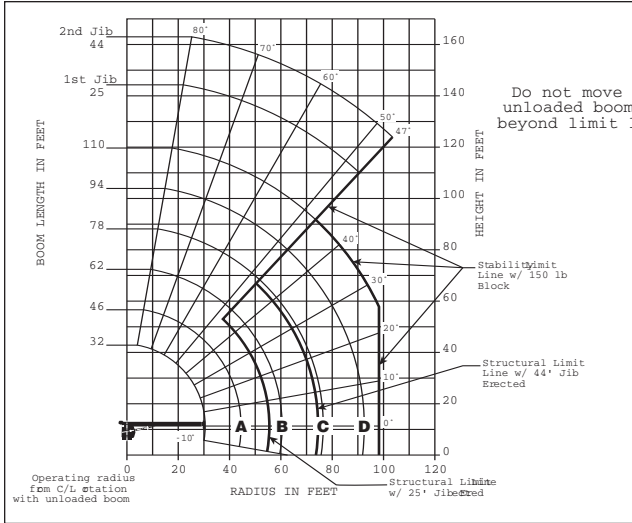

CAUTION:

- Do not operate crane booms, jib extensions, any accessories or loads within 10 ft (3m) of live power lines or other conductors of electricity.
- Jib and boom capacities shown are maximum for each section.
- Do not exceed capacities at reduced radii.
- Load ratings shown on the appropriate charts are maximum allowable loads with the crane mounted on a factory-approved truck and all outriggers at either full span or at mid span range and set on a firm level surface so that the crane is level and all tires are suspended.
- Always level the crane with the level indicator located on the crane.
- The operator must reduce load to allow for factors such as wind, ground conditions, operating speeds and their effects on freely suspended loads.
- Overloading this crane may cause structural collapse or instability.
- Weights on any accessories attached to the boom or loadline must be deducted from the load chart capacities.
- Do not exceed jib capabilities at any reduced boom lengths.
- Do not deadhead lineblock against boom tip when extending boom or winching up.
- Keep at least three wraps of loadline on drum at all times.
- Use only specified cable with this machine.

**SERIES 13110A
WITH
25-44 ft JIB /
FULL-SPAN
OUTRIGGER 20 ft**

NOTE:

1. Operate with jib by radius when main boom is fully extended. If necessary increase boom angle to maintain loaded radius.
2. Operate with jib by boom angle when main boom is not fully extended. Do not exceed rated jib capacities at any reduced boom lengths.

LOADLINE EQUIPMENT DEDUCT

Downhaul weight.....150 lb (68 kg)
One sheave block266 lb (120 kg)
Two sheave block.....350 lb (159 kg)
Three sheave block.....575 lb (261 kg)

Load Chart Rating: Series 13110A (33.5 m) Boom with 25 ft-44 ft (7.62 m-13.4 m) Jib / Full-Span Outrigger 20 ft (6.0 m)

32 ft – 110 ft BOOM RATED LOADS WITHOUT JIB

LOADED RADIUS (ft)	LOADED BOOM ANGLE (deg)	32 ft BOOM (ft)	A 46 ft BOOM (ft)	LOADED BOOM ANGLE (deg)	B 62 ft BOOM (ft)	LOADED BOOM ANGLE (deg)	C 78 ft BOOM (ft)	LOADED BOOM ANGLE (deg)	D 94 ft BOOM (ft)	LOADED BOOM ANGLE (deg)	110 ft BOOM (ft)		
5	78.5	60,000											
8	74.5	43,000											
10	70.5	35,900	77.5	29,100									
12	66.5	30,900	75	28,900									
15	60	25,500	71	24,000	77	23,000							
20	48.5	19,450	63.5	18,450	72	17,550	77	17,000					
25	34	14,900	56	14,800	67	14,100	73	13,600	77.5	13,300			
30			48	12,150	61.5	11,650	69	11,200	74	10,950	77	7,950	
35			38.5	9,600	56	9,850	64.5	9,450	70.5	9,200	74	6,300	
40			27	7,600	49.5	7,950	60.5	8,100	67	7,850	71.5	5,950	
45					43.5	6,350	56	6,600	64	6,800	69	5,700	
50					36	5,100	51.5	5,350	60	5,550	66	5,400	
55					26	4,050	46	4,300	56	4,550	63	4,750	
60						8.5	2,650	40	3,500	52	3,700	59.5	3,900
65								33.5	2,850	48	3,000	56	3,200
70								25.5	2,250	43	2,450	52.5	2,600
75								13	1,750	38	1,950	49	2,100
80										32	1,500	45	1,650
85										25	1,100	41	1,250
90										15	750	36	900
95												31	600
100													
		0	6,300	0	3,250	0	1,450	0					

25 – 44 ft JIB RATED LOADS				
LOADED RADIUS (ft)	LOADED BOOM ANGLE (deg)	25 ft JIB (ft)	LOADED BOOM ANGLE (deg)	44 ft JIB (ft)
35	76.5	4,200		
40	75	4,100	76.5	2,500
45	73	4,000	75.5	2,500
50	71	3,850	74	2,500
55	69	3,600	72.5	2,500
60	66.5	3,300	70.5	2,350
65	64	3,050	68.5	2,250
70	61.5	2,500	66.5	2,150
75	59	2,000	64.5	2,050
80	56	1,550	62	1,900
85	53.5	1,100	60	1,800
90	50.5	700	57	1,400
95			54.5	1,050
100			51.5	650
105				

*SHADED AREAS ARE STRUCTURALLY LIMITED CAPACITIES

1300A

BOOM LENGTH (ft)	25 – 44 ft JIB STOWED
29	Reduce load 800 lb
44	Reduce load 600 lb
58	Reduce load 450 lb
72	Reduce load 350 lb
86	Reduce load 300 lb
100	Reduce load 250 lb

RATED LOAD REDUCTIONS WITH STOWED JIB

Note:

1. All capacities are in pounds, angles in degrees, and radii in feet.
2. Loaded boom angles are given as reference only.
3. Shaded areas are structurally limited capacities.
4. Handling of personnel is only permitted with full span extension of all outrigger and stabilizer beams.
- *5. See owners manuals. The 60,000 lb load requires optional 9/16" diameter 6x25 IWRC cable.

THIS CHART IS ONLY A GUIDE AND SHOULD NOT BE USED TO OPERATE THE CRANE. The individual crane's load chart, operating instructions and other instructional plates must be read and understood prior to operating the crane.

capacities

Load Chart Rating: Series 13110A (33.5 m) Boom with 25-44 ft (7.62 m-13.4 m) Jib / Mid-Span Outrigger 14 ft (4.3 m)

National Crane will send you a chart on request – or you may secure needed load rating information through your nearest National Crane dealer.

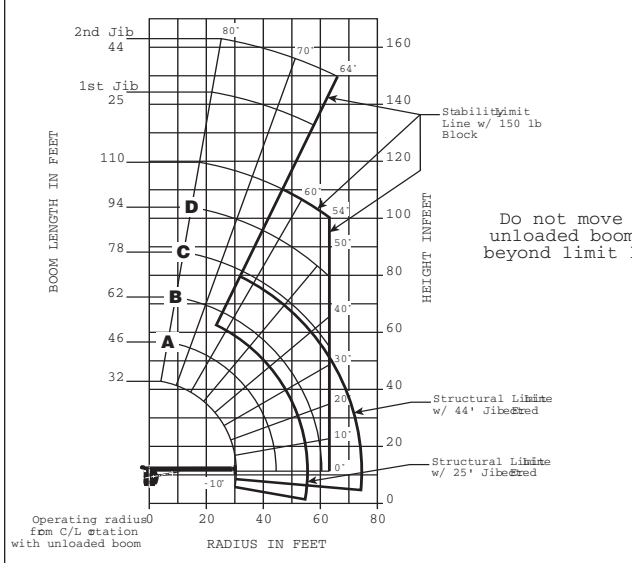

CAUTION:

- Do not operate crane booms, jib extensions, any accessories or loads within 10 ft (3m) of live power lines or other conductors of electricity.
- Jib and boom capacities shown are maximum for each section.
- Do not exceed capacities at reduced radii.
- Load ratings shown on the load rating charts are maximum allowable loads with the outriggers properly extended and the outrigger lock pins engaged on a firm, level surface and the crane leveled and mounted on a factory recommended truck.
- Always level the crane with the level indicator located on the crane.
- The operator must reduce load to allow for factors such as wind, ground conditions, operating speeds and their effects on freely suspended loads.
- Overloading this crane may cause structural collapse or instability.
- Weights on any accessories attached to the boom or loadline must be deducted from the load chart capacities.
- Do not exceed jib capabilities at any reduced boom lengths.
- Do not deadhead lineblock against boom tip when extending boom or winching up.
- Keep at least three wraps of loadline on drum at all times.
- Use only specified cable with this machine.

**SERIES 13110A
WITH
25-44 ft JIB /
MID-SPAN
OUTRIGGER 14 ft**

LOADLINE EQUIPMENT DEDUCT

Downhaul weight.....150 lb (68 kg)
One sheave block.....266 lb (120 kg)
Two sheave block.....350 lb (159 kg)
Three sheave block.....575 lb (261 kg)

NOTE:

- Operate with jib by radius when main boom is fully extended. If necessary increase boom angle to maintain loaded radius.
- Operate with jib by boom angle when main boom is not fully extended. Do not exceed rated jib capacities at any reduced boom lengths.

Load Chart Rating: Series 13110A (33.5 m) Boom with 25-44 ft (7.62 m-13.4 m) Jib / Mid-Span Outrigger 14 ft (4.3 m)

32 ft – 110 ft BOOM RATED LOADS WITHOUT JIB

LOADED RADIUS (ft)	LOADED BOOM ANGLE (deg)	32 ft BOOM (ft)	LOADED BOOM ANGLE (deg)	A 46 ft BOOM (ft)	LOADED BOOM ANGLE (deg)	B 62 ft BOOM (ft)	LOADED BOOM ANGLE (deg)	C 78 ft BOOM (ft)	LOADED BOOM ANGLE (deg)	D 94 ft BOOM (ft)	LOADED BOOM ANGLE (deg)	110 ft BOOM (ft)
5	78.5	*60,000										
8	74.5	43,000										
10	70.5	35,900	77.5	34,100								
12	66.5	30,900	75	29,200								
15	60	24,300	71	24,000	77	20,000						
20	48.5	13,300	63.5	13,950	72	14,400	76.5	14,900				
25	34	8,350	56	8,900	66.5	9,600	72	9,600	76.5	10,000		
30			48	6,150	61.5	6,500	68.5	6,750	73	6,900	76.5	7,250
35			38.5	4,300	55.5	4,650	64	4,850	69.5	5,050	73.5	5,350
40			26.5	3,050	49.5	3,350	59.5	3,550	66	3,700	70.5	3,900
45					43	2,350	55	2,550	62.5	2,700	67	2,850
50					35	1,650	50	1,800	58.5	1,950	64	2,050
55					25	1,000	45	1,200	55	1,350	61	1,450
60					8	550	39	750	50.5	850	58	950
65											54.5	500
70												
0		5,300	0	2,100	0	500						

*SHADED AREAS ARE STRUCTURALLY LIMITED CAPACITIES

25 – 44 ft JIB RATED LOADS				
LOADED RADIUS (ft)	LOADED BOOM ANGLE (deg)	25 ft JIB (ft)	LOADED BOOM ANGLE (deg)	44 ft JIB (ft)
35	76.5	4,200		
40	75	4,100	76.5	2,500
45	73	2,650	75.5	2,500
50	71	1,800	74	2,500
55	69	1,200	72.5	2,000
60	66.5	700	70.5	1,400
65			68.5	950
70				

BOOM LENGTH (ft)	25 – 44 ft JIB STOWED
29	Reduce load 800 lb
44	Reduce load 600 lb
58	Reduce load 450 lb
72	Reduce load 350 lb
86	Reduce load 300 lb
100	Reduce load 250 lb

RATED LOAD REDUCTIONS WITH STOWED JIB

Note:

- All capacities are in pounds, angles in degrees, and radii in feet.
- Loaded boom angles are given as reference only.
- Shaded areas are structurally limited capacities.
- Handling of personnel is only permitted with full span extension of all outrigger and stabilizer beams.
- See owners manuals. The 60,000 lb load requires optional 9/16" diameter 6x25 IWRC cable.

THIS CHART IS ONLY A GUIDE AND SHOULD NOT BE USED TO OPERATE THE CRANE. The individual crane's load chart, operating instructions and other instructional plates must be read and understood prior to operating the crane.

accessories

10

Radio Remote Controls –

Eliminate the handling and maintenance concerns that accompany cabled remotes. Operate to a range of about 250 ft (76 m), varying with conditions.

• **NB4R**

One-Person Basket –

Strong but lightweight steel basket with 300 lb (139-kg) capacity, gravity hung with swing lock and full body harness.

• **B1-S**
• **2B1-S** (for dual locking baskets)

Heavy-duty Personnel Basket –

1,200 lb (544 kg) capacity steel basket with safety loops for four passengers. Gravity leveling 72 x 42 in (183 x 107 cm) platform. Fast attachment and secure locking systems. Load chart must show 2,300 lb (1043 kg) minimum to operate this accessory.

• **BSA-1**
• **BSA-R1** (provides rotation)

Air Conditioning –

Back of cab mounted, self contained modular unit with in cab cool air outlets. Requires 130+ amp. chassis alternator.

• **AC**

Winch Drum Rotation Indicator

• **WDRI**

Last Wrap Indicator Option on winch with indicator in cab.

• **LLI**

Outrigger Controls at operator's seat in addition to ground controls.

• **ICORC**

Single Front Outrigger –

Center mount front stabilizer with a 25 in vertical stroke with first-up feature.

• **SFO**

Outrigger Motion Alarm –

Outrigger motion alarm with and without SFO.

• **OMA-3**

Hour Meter –

Hour meter in truck cab to record crane operation hours.

• **HRM**

Hook Block Stowage –

Hook block and downhaul weight stowage box attached to the boom rest.

• **HBSB**

Open Seat Controls –

Open seat controls with railing in lieu of cab.

• **SSC**

Steel Tool Box Options

Spanish-Language Danger Decals, Control Knobs, and Operators' Manuals

• **SDD**
• **SOM**

1300A

dimensions specifications

Dimensions Specifications

G CENTER OF GRAVITY FROM CENTERLINE	
SERIES	W/OIL WEIGHT*
1369A	112** [11,568 kg]**
13100A	153 [12,474kg]
13110A	168 [13,209 kg]

*WEIGHT INCLUDES ALL ITEMS INCLUDING COMPLETE HO OUTRIGGERS, 180 lb [82 kg] DOWNHAUL WEIGHT, RESERVOIR, WOOD DECKS, OIL COOLER, LADDERS, JIB & CAB. BOOMS FULLY RETRACTED.
 **JIB IS NOT INCLUDED IN 69 ft BOOM WEIGHT & CG

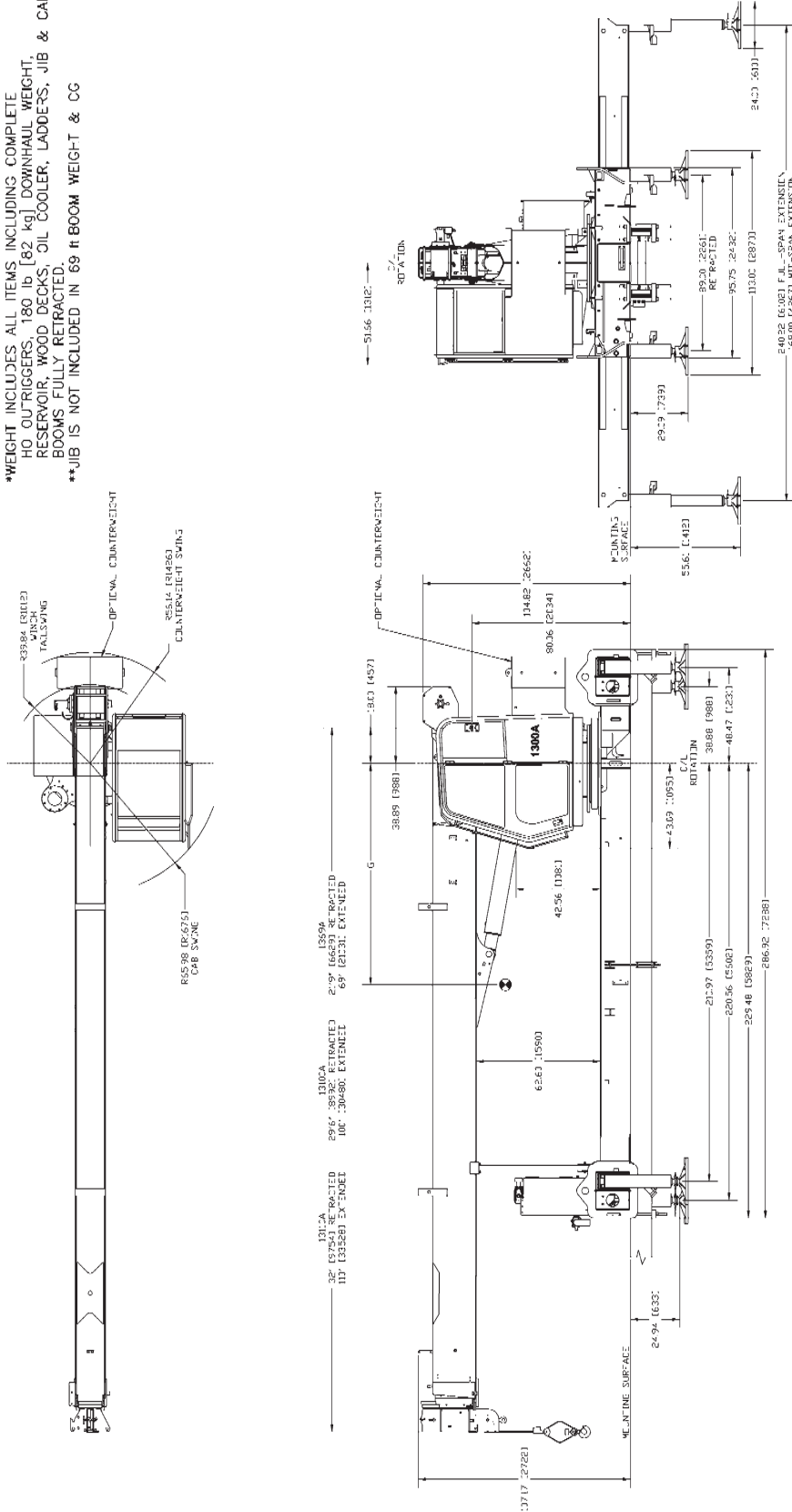

Regional Headquarters

Americas

Manitowoc, Wisconsin, USA

Tel: +1 920 684 6621

Fax: +1 920 683 6278

Shady Grove, Pennsylvania, USA

Tel: +1 717 597 8121

Fax: +1 717 597 4062

Regional Offices

Americas

Brazil

Alphaville

Tel: +55 11 4688 2716

Fax: +55 11 4191 1471

Mexico

Monterrey

Tel: +52 81 8124 0128

Fax: +52 81 8124 0129

Europe, Middle East, Africa

Algeria

Hydra

Tel: +21 3 21 48 1173

Fax: +21 3 21 48 1454

Czech Republic

Netvorice

Tel: +420 317 78 9313

Fax: +420 317 78 9314

France

Baudemont

Tel: +33 385 28 2589

Fax: +33 385 28 0430

Cergy

Tel: +33 130 31 3150

Fax: +33 130 38 6085

Decines

Tel: +33 472 81 5000

Fax: +33 472 81 5010

Germany

Langenfeld

Tel: +49 21 73 8909-0

Fax: +49 21 73 8909 30

Hungary

Budapest

Tel: +36 13 39 8622

Fax: +36 13 39 8622

Italy

Parabiago

Tel: +390 331 49 3311

Fax: +390 331 49 3330

Europe, Middle East, Africa

Ecully, France

Tel: +33 472 18 2020

Fax: +33 472 18 2000

Netherlands

Breda

Tel: +31 76 578 3999

Fax: +31 76 578 3978

Poland

Warsaw

Tel: +48 22 843 3824

Fax: +48 22 843 3471

Portugal

Alfena

Tel: +351 229 69 8840

Fax: +351 229 69 8848

Lisbon

Tel: +351 212 109 340

Fax: +351 212 109 349

Russia

Moscow

Tel: +7 495 641 2359

Fax: +7 495 641 2358

U.A.E.

Dubai

Tel: +971 4 3381 861

Fax: +971 4 3382 343

U. K.

Middlesex

Tel: +44 1 895 43 0053

Fax: +44 1 895 45 9500

Sunderland

Tel: +44 191 522 2000

Fax: +44 191 522 2052

Asia – Pacific

Australia

Melbourne

Tel: +61 3 9 336 1300

Fax: +61 3 9 336 1322

Sydney

Tel: +61 2 9 896 4433

Fax: +61 2 9 896 3122

Asia – Pacific

Shanghai, China

Tel: +86 21 51113579

Fax: +86 21 51113578

Singapore

Tel: +65 6264 1188

Fax: +65 6862 4142

China

Beijing

Tel: +86 10 58674761

Fax: +86 10 58674760

Xi'an

Tel: +86 29 87891465

Fax: +86 29 87884504

Korea

Seoul

Tel: +82 2 3439 0400

Fax: +82 2 3439 0405

Philippines

Makati City

Tel: +63 2 844 9437

Fax: +63 2 844 4712

Factories

U.S.A.

Manitowoc

Shady Grove

Brazil

Alphaville

France

Charlieu

La Clayette

Moulins

India

Calcutta

Puna

Italy

Niella Tanaro

Germany

Wilhelmshaven

Portugal

Fânzeres

China

Zhangjiagang



Constant improvement and engineering progress make it necessary that we reserve the right to make specification, equipment and price changes without notice. Illustrations shown may include optional equipment and accessories, and may not include all standard equipment.